



FPL®

FPL SolarNow™ Program Community Based Solar Offering

10 December 2016

FPL SolarNow is a community based solar program dedicated to promoting and advancing solar energy in our

Coming together to advance solar

FPL SolarNow Program

- ~~Participants volunteer to contribute \$9/month~~
- FPL utilizes the funds to build, own, and operate solar
- Community hosts provide the space needed to support the generation
- Solar generation in the community drives awareness

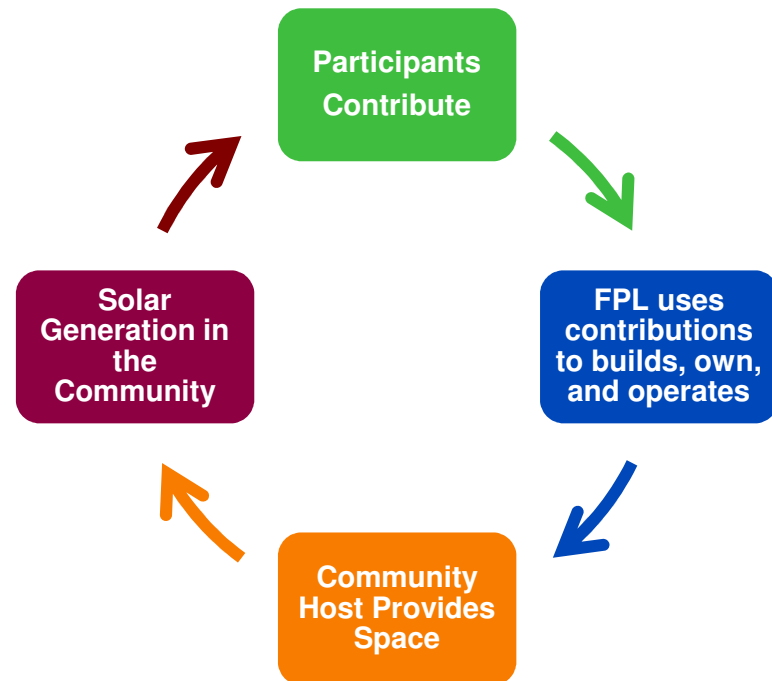

FPL SolarNow program brings the community together to fund, build and generate clean solar energy

Program is committed to deploying solar in communities where the participants live and where they come together as a community

FPL SolarNow Program - Participation

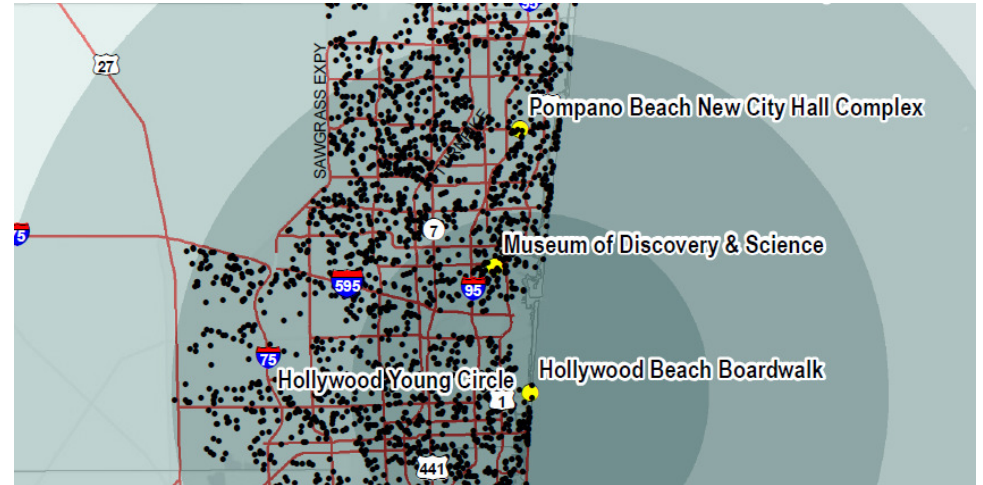
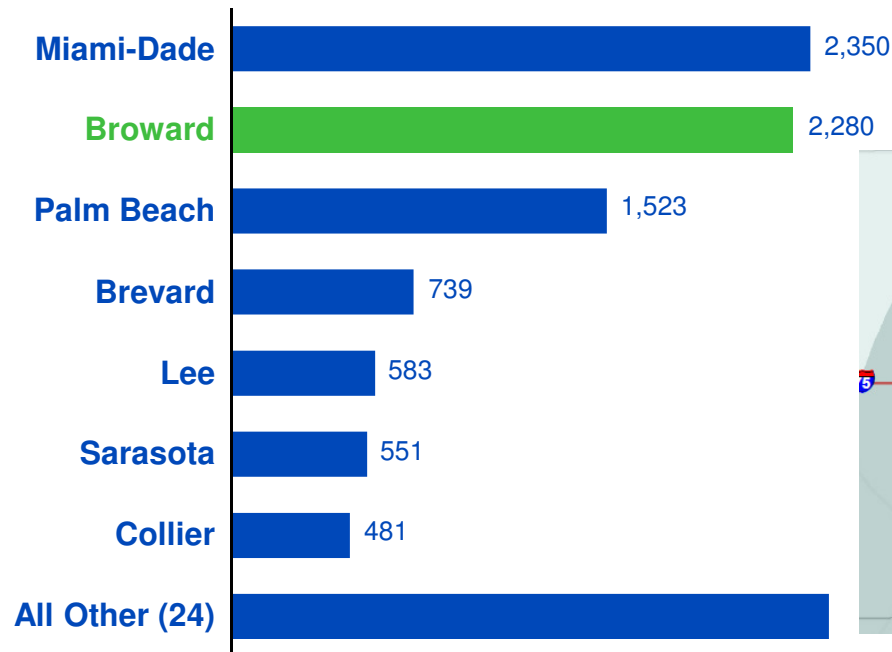

FPL SolarNow is a unique program, that offers everyone with the opportunity to participate in the growth of solar in our communities

Broward County and Top Cities Graphic

FPL SolarNow Program - Participation

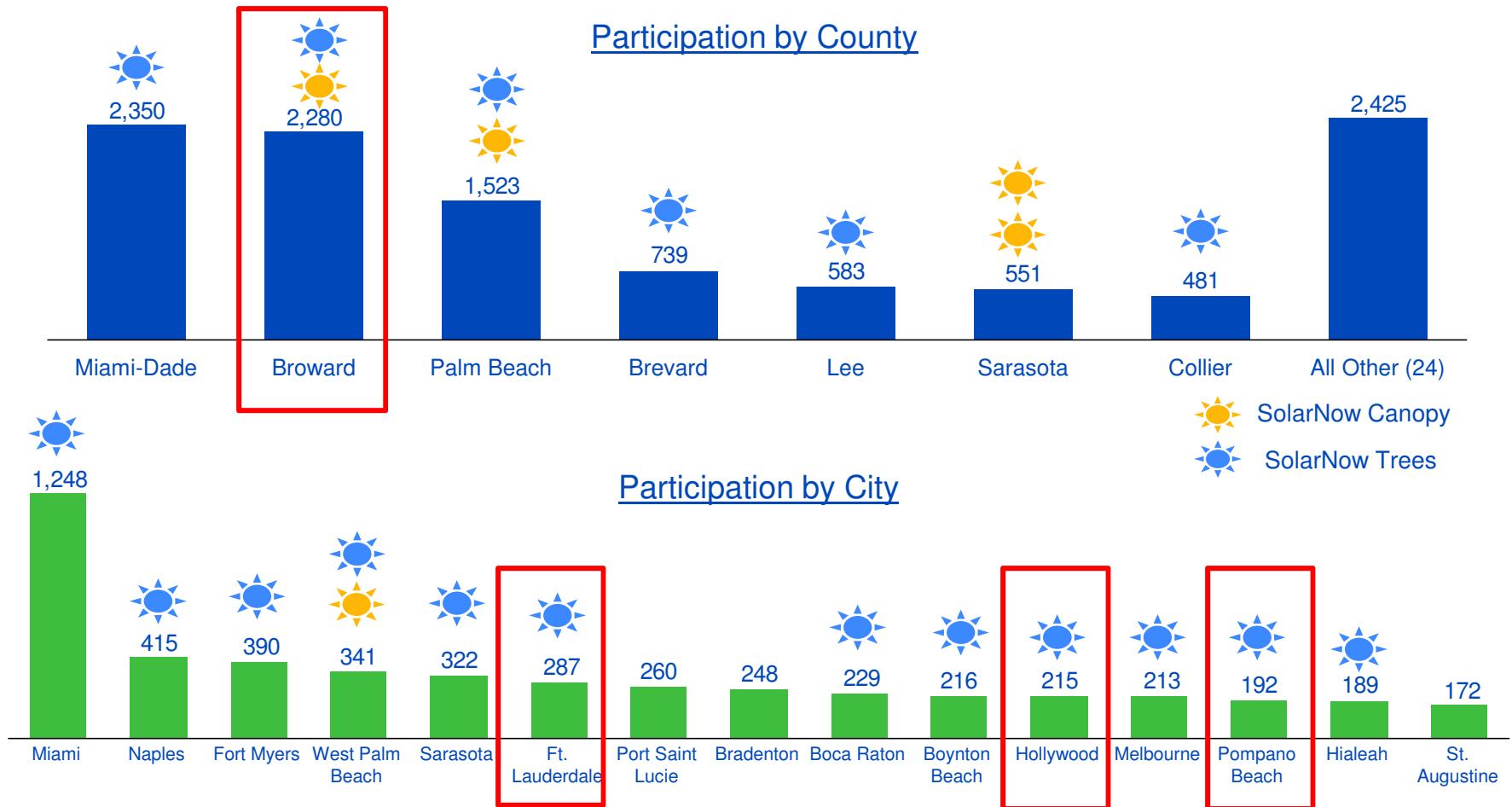

FPL SolarNow projects work best in pedestrian areas where people of all ages and interests come together

FPL SolarNow Host Locations



- **Community locations of great civic pride**
- **Pedestrian friendly areas**
- **Open areas with limited shade**



Artist rendering

FPL SolarNow projects showcase and inspire clean energy stewardship



FPL SolarNow program brings beautiful solar structures to our communities

Spotlight Solar Overview

- **Spotlight's solar trees**
 - Progressive design
 - Thoroughly engineered for high wind loading
 - Simple kitted installation
- **2 models meet Florida building code**
 - Curve; 6 panels ~1.5 kW
 - Lift; 12 panels ~3.0 kW



Artist rendering

Solar structures create interest in open areas and work best in heavily trafficked pedestrian spaces with minimal shade

Curve solar tree is approximately 18 feet tall and creates up to 100 square feet of shade

Solar Tree – Curve Design



Artist renderings



Lift solar tree is approximately 24 feet tall and creates upto 200 square feet of shade

Solar Tree – Lift Design

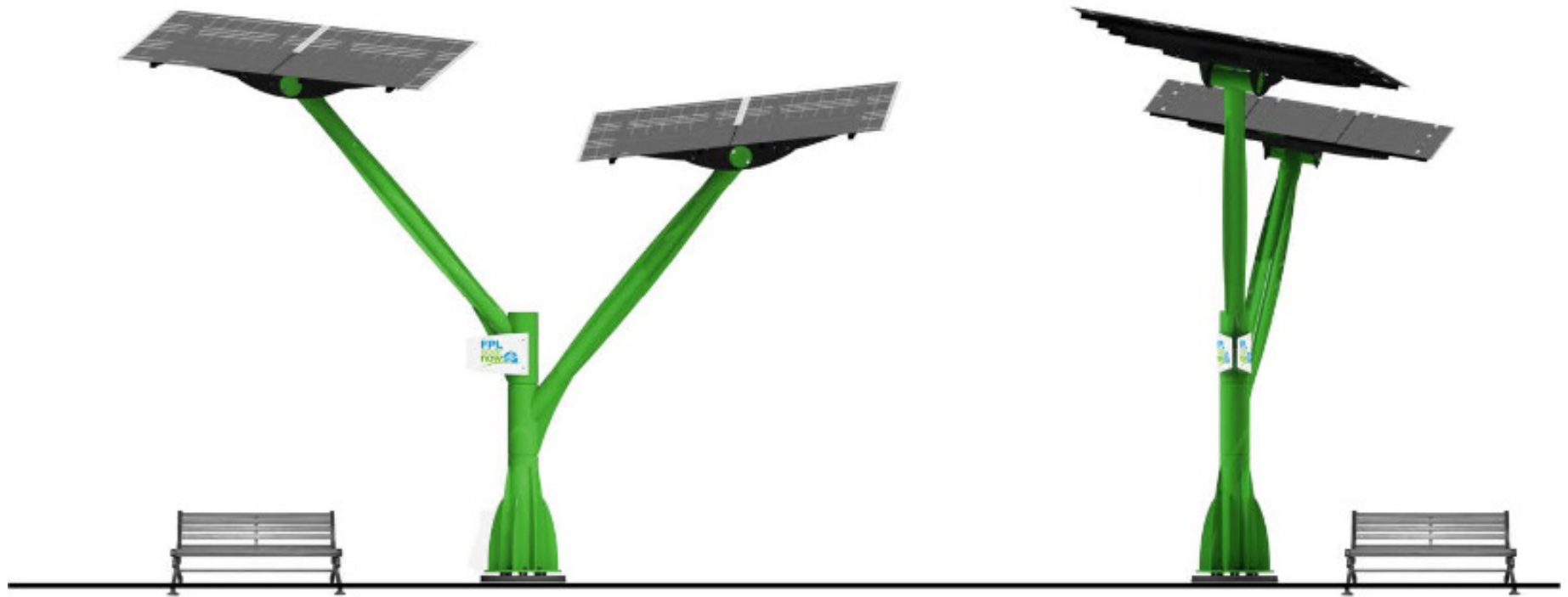

Artist renderings

Cellphone chargers and tables can be incorporated in the solar trees

Pompano Beach Library & Cultural Center



Solar Trees could enhance the experience around the Library & Cultural Center

Appendix Slides

Two products meet the Florida building code and complement a variety of outdoor areas

Spotlight Solar Products

Lift

- 20-25' tall
- 12 Lumos Modules: 3 kW
- Adjustable arms and arrays

Curve

- 17-20' tall
- 6 Lumos Modules: 1.5 kW
- Adjustable arrays

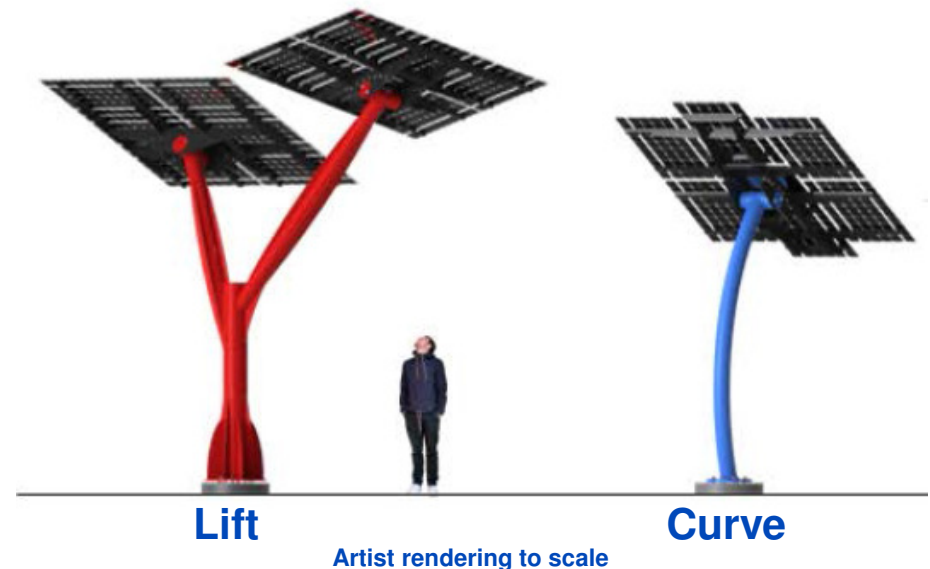

The complete assembly (structure and array) for these products meet wind load ratings of 175 MPH

Curve and Lift dimensions can enhance interaction with solar trees

Spotlight Solar Products

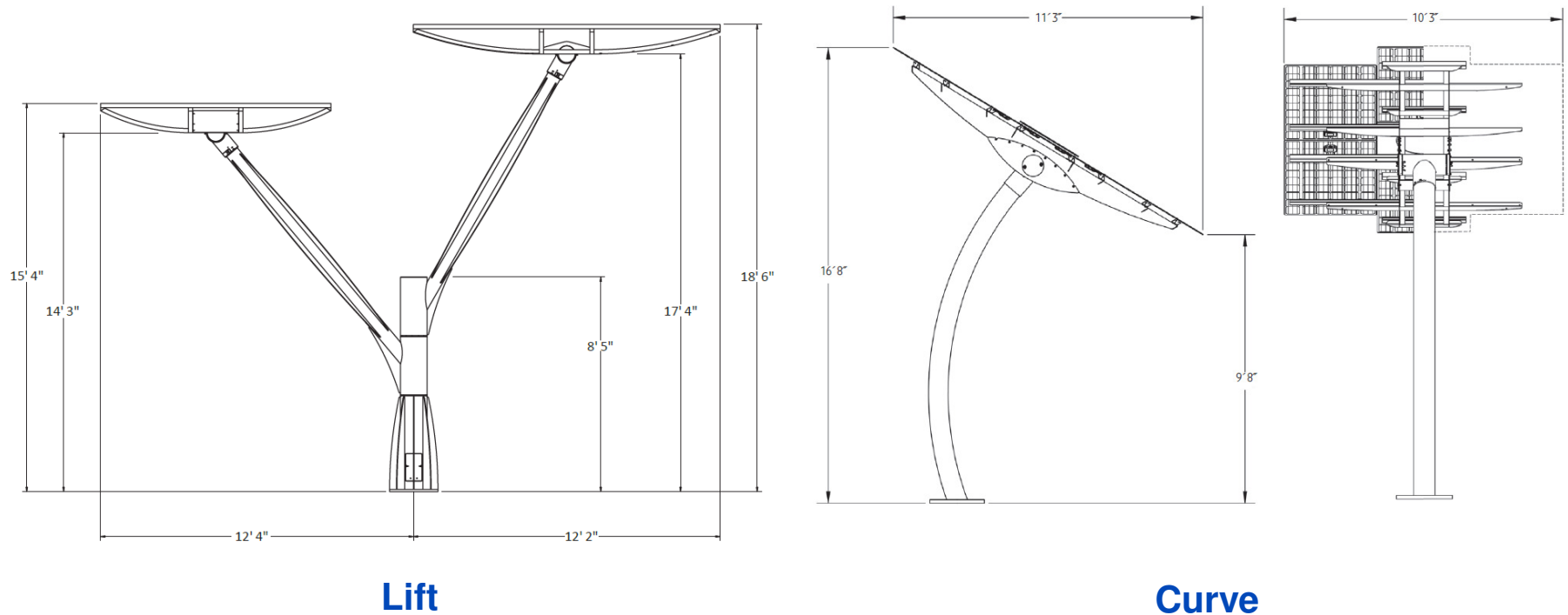

Product dimensions should be taken into account when determining location of solar trees

Lift structures along the passenger drop-off at Manatee Lagoon create shade areas for visitors at the main entrance

Manatee Viewing Center: 2 Lifts



Artist rendering, final design subject to mutual party approval

Curve structures along entry median greet employees and visitors

Juno Beach HQ: 3 Curves in Entrance Median



Artist rendering, final design subject to mutual party approval
Landscaping not to scale



Covered parking for employees and visitors

Juno Beach HQ: Canopies w/Car Charging Stations



Artist rendering, final design subject to mutual party approval
Landscaping not to scale